

Discrete Downlight - LL-1003-5B15-95S8W9-300

www.lumenall.com.au

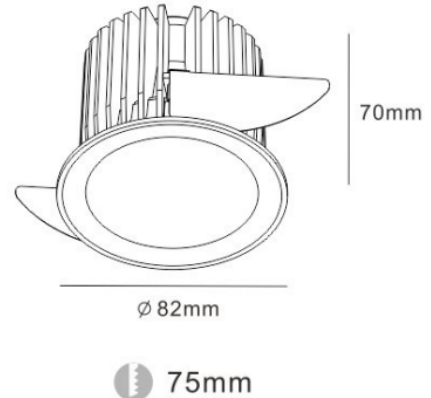

General Specifications

| | |
|---------------|--------------------|
| Product Name | Discrete Downlight |
| Product Range | Discrete Downlight |
| Product Code | LL-1003 |
| IP Rating | IP44 Room side |
| Finish | black |
| Dimensions | 95mm |

Additional Specifications

| | |
|-------------|------------------|
| Optics | 15 |
| Accessories | |
| Mounting | Recessed springs |
| Diffuser | Clear |
| UGR | <19 |

Supplier Information

| | |
|----------------|-------------------|
| Distributor | Lumenall Lighting |
| Contact Person | Sean Boxshall |
| Lead Time | 4 - 12 Weeks |
| Warranty | 5 Years |

LED

| | |
|------------------------|---|
| Lamp Type | Cree CXA1507 COB |
| Power | 8w |
| Colour Temperature | 5000k |
| CRI | 90 |
| Colour Deviation | SDCM < 3 |
| Absolute Luminous Flux | Upto 90lm-w |
| Lifespan | Calculated L70 - 60,000h Reported L70 > 39,000 |

Electronic Control Gear

| | |
|-------------------|----------------------------------|
| Type | Lumenall Driver - Gen 2 |
| Rating | 300ma |
| Built in / Remote | Remote / Dimmable (Phase cut) |
| Power Factor | > 0.95 |

Additional Information

DALI options available, Tridonic driver.