

# Discrete Downlight - LL-1003-5B36-70L8W9-250

www.lumenall.com.au

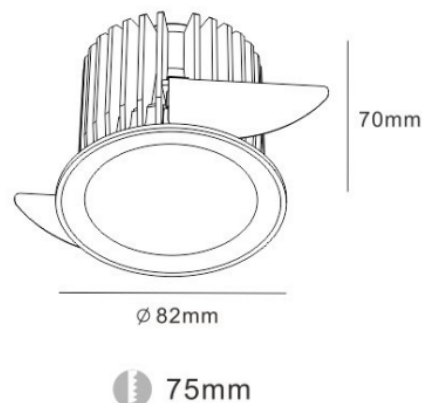

## General Specifications

Product Name	Discrete Downlight
Product Range	Discrete Downlight
Product Code	LL-1003
IP Rating	IP44 Room side
Finish	black
Dimensions	70mm

## Additional Specifications

Optics	36
Accessories	
Mounting	Recessed springs
Diffuser	Clear
UGR	<19

## Supplier Information

Distributor	Lumenall Lighting
Contact Person	Sean Boxshall
Lead Time	4 - 12 Weeks
Warranty	5 Years

## LED

Lamp Type	Cree CXA1507 COB
Power	8w
Colour Temperature	5000k
CRI	90
Colour Deviation	SDCM < 3
Absolute Luminous Flux	Upto 90lm-w
Lifespan	Calculated L70 - 60,000h Reported L70 > 39,000

## Electronic Control Gear

Type	Lumenall Driver - Gen 2
Rating	250ma
Built in / Remote	Remote / Dimmable (Phase cut)
Power Factor	> 0.95

## Additional Information

DALI options available, Tridonic driver.